

INSTALLATION AND OPERATION GUIDE FOR

HARGROVE GAS LOGS

(SS) SEE THRU SHALLOW SETS

PROPANE GAS

ADEQUATE FIREPLACE VENTILATION IS REQUIRED FOR SAFETY

GAS LOGS MUST BE INSTALLED BY PERSONNEL QUALIFIED FOR INSTALLING GAS APPLIANCES.

NOTE !

READ INSTRUCTIONS FULLY BEFORE INSTALLING OR OPERATING.

INSTALLER LEAVE THESE INSTRUCTIONS WITH CONSUMER!

Hargrove Manufacturing Corporation uses refractory material to create ceramic logs. Each log is hand finished to assure the most realistic, detailed log available. The gas log burner system is designed to burn like wood – with a yellow smoky flame. For this reason the gas log set must be burned only in a fully vented, non-combustible fireplace with the **damper completely open** and the chimney free of any obstructions or restrictions. The fireplace must be designed and approved to burn wood. The minimum permanent, free opening provided by the fireplace chimney must be 8" in diameter (50 square inches).

IT IS THE HOME OWNERS RESPONSIBILITY TO ASSURE THEIR FIREPLACE HAS ADEQUATE DRAFT.

The realistic yellow flame produces carbon monoxide and soot. Under normal conditions these products are exhausted up the chimney. If fumes or soot from the gas burning are evidenced in the room when the damper is fully open, it indicates that the fireplace draft is defective. Do not operate your gas log set until the fireplace draft is corrected.

ADEQUATE VENTILATION IS REQUIRED.

FOR YOUR SAFETY

IF YOU SMELL GAS:

1. OPEN WINDOWS
2. DON'T TOUCH ELECTRICAL SWITCHES
3. EXTINGUISH ANY OPEN FLAMES
4. IMMEDIATELY CALL YOUR GAS SUPPLIER

FLAMMABLE VAPORS MAY BE DRAWN BY AIR CURRENTS FROM OTHER AREAS OF YOUR HOUSE TO THIS APPLIANCE.

FOR YOUR SAFETY

DO NOT STORE OR USE GASOLINE OR OTHER FLAMMABLE VAPORS AND LIQUIDS IN THE VICINITY OF THIS OR ANY OTHER APPLIANCE.

THE SIZE CHART BELOW INDICATES THE MINIMUM SIZE FIREPLACE OPENINGS IN WHICH DIFFERENT SIZE GAS LOG SETS CAN BE INSTALLED.

FIREPLACE SIZES

GAS LOG SET SIZE	DEPTH & HEIGHT	FRONT WIDTH
18"	17"	24"
24"	17"	28"
30"	17"	34"

GENERAL INFORMATION

DO NOT USE A NATURAL GAS SET FOR PROPANE OR A PROPANE SET FOR NATURAL GAS. WHEN USING PROPANE (LPG) GAS AN AUTOMATIC PILOT SYSTEM MUST BE INSTALLED ON EACH EMBER BURNER.

1. There are many different local codes for gas fire logs. The installation of this set must conform with local codes or, in the absence of local codes, with the National Fuel Gas Code ANSI Z223.1 1984.
2. ***This log set is designed for use with Propane Gas.***
3. When glass fireplace doors are used always operate gas log set with the doors fully open to allow for proper combustion air.
4. A fire screen must be in place when the log set is in use.
5. The appliance and its individual shut off valve must be disconnected from the gas supply piping system at test pressures in excess of 1/2 psig. The appliance must be isolated from the gas supply piping system by closing its individual manual shut off valve during any pressure testing of gas supply system at test pressures equal to or less than 1/2 psig.
6. Minimum inlet supply pressure for Propane Gas is 11" water column. Maximum inlet supply pressure for Propane Gas is 13" water column.
7. After burning, the logs become fragile and should not be handled. Knocking or rubbing logs can cause concrete to crumble and is not covered under the warranty.
8. Use a soft, dry paintbrush for periodic dusting of the gas fire logs. Special care must be taken to clean the Birch logs. Rubbing will remove soot but will also remove the white pigments.
9. ***Do not burn wood with this set.***

NOTE: GAS LOGS MUST BE INSTALLED BY PERSONNEL QUALIFIED TO INSTALL GAS APPLIANCES.

INSTALLING YOUR H A R G R O V E GAS LOGS

Remove all the parts from the shipping container. Your set includes the following parts...

<u>Number by Set</u>	<u>18" Set</u>	<u>24" Set</u>	<u>30" Set</u>
1. See Thru Narrow Grate	STGN-16	STGN-20	STGN-25
2. See Thru Burner Narrow	(2) EB-14	(2) EB-18	(2) EB-22
3. Vermiculite	VM-2	VM-2 (M)	VM-2 (L)
4. Fire Embers	EM-2	EM-2	EM-2
5. Safety Pilot Control	(2) SPC	(2) SPC	(2) SPC
6. Aluminum Connector	(2) AC-18	(2) AC-18	(2) AC-18
7. Fire Logs	* Number of logs determined by set size		
8. Damper Stop (optional)	D S	D S	D S
9. Volcanic Cinders	VC-2	VC-2	VC-2
10. Air Mixer	(2) AM	A M	A M

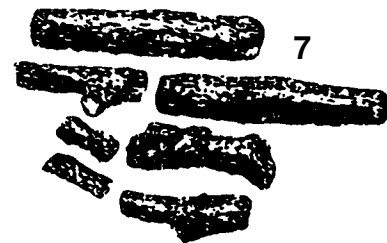
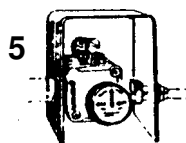
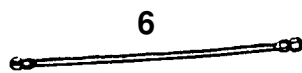
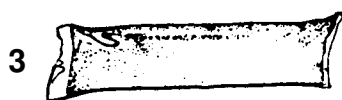
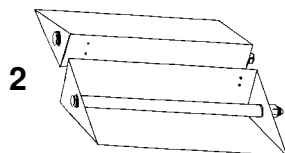
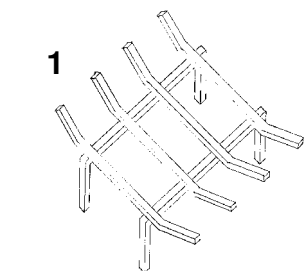

DAMPER STOP (optional)

Attach the **damper stop** clamp to the fireplace damper blade. Position the clamp to prevent full closure of the fireplace damper blade.

(See Figure 1)

If the damper stop provided does not fit, the installer shall install a permanent damper stop that will keep the damper open a minimum of 3".

* CAUTION *

THE DAMPER MUST BE FULLY OPEN WHEN OPERATING THE GAS LOGS !

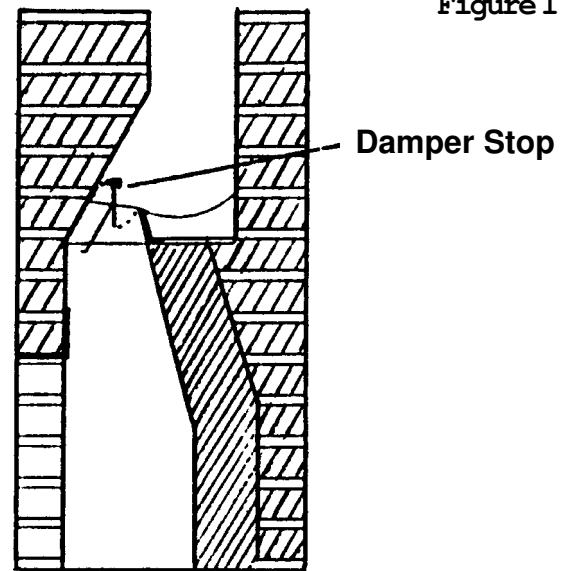

EMBER BURNER POSITIONING

1. Turn gas **off**.
2. Remove old log lighter, ashes, and other material from the firebox.
3. Center the **ember burners** on the fireplace floor with the burner pipes completely visible from both fireplace openings. For best results the ember burners should be directly under the flue opening with a minimum of 4" from the front edge of the ember burner to the fireplace opening. (See Figure 2)
4. Place the **grate** over the ember burners. Once the final positioning is established, mark the burner and grate position on the floor of the fireplace for reference points. Remove the grate and proceed with the gas connection.
(See Figure 2.)

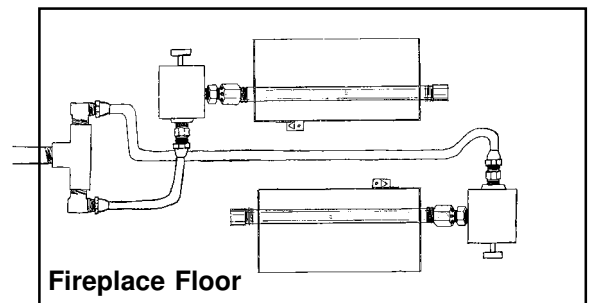

GAS CONNECTION

1. The gas supply line should be 1/2" Inside Diameter (ID) up to 30 feet and 3/4" for longer distances.
2. Use the **aluminum connector** to connect gas supply to the **safety pilot control** on each burner pan as shown in the pilot control installation instructions. When bending aluminum tubing use proper bending procedures to avoid kinking the tube.
3. Check all connections for leaks using a soapy water solution.
4. Damper must remain fully open during operation. Ignite gas by following the lighting instructions included with the safety pilot control. Turn the gas supply on slowly until the gas ignites. Check the flame for even distribution, flame height and pressure. After checking the flame turn off the fire. (To turn off the fire turn the gas valve off.) Do not close the damper until all the flames have died. Keep the glass doors fully open during all burning.

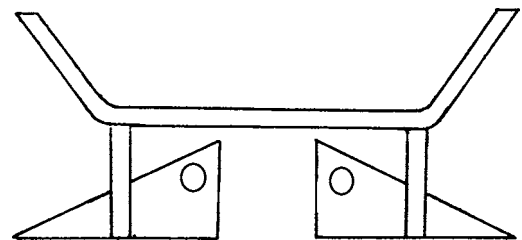

BURNER PAN MEDIA

Figure 4

1. Fill the burner pan with **vermiculite**. Vermiculite level should be sloped evenly with the sides of ember burner. Place 2/3 of the **Part A Embers** on top of the vermiculite. Burner should be completely full and level.
2. Light the gas and observe flame for even distribution.
3. **Part B Embers** (rockwool) are placed over the vermiculite to simulate glowing embers. For best results pinch off pieces of the Part B material the size of a dime and feather it out. Place as much as desired over the area the gas comes through. (See Figure 3.)

PILOT LIGHT

The **pilot light** should be checked periodically to assure proper flame. Half the flame should be blue directed over the pan but unobstructed by the pan or the material in the pan. The other half of the flame should be directed onto the thermocouple. When turning the main burner on, the pilot flame should ignite the gas within 4 seconds without creating a big poof.

GRATE PLACEMENT

Place the **grate** over the ember burner using the reference marks made on fireplace floor earlier.

LOG PLACEMENT

1. The longest logs are the **front logs**. They should be placed on each side of the grate with the flat, unfinished side facing the middle and the bark texture facing out. It is essential for these two logs to be positioned in this manner. (If the logs are laid flat on the grate the safety pilot control parts will over heat and shut the system off.)
2. The remaining logs are **top logs**. These logs are placed diagonally across the bottom logs and can be arranged to create the most realistic flame patterns. (See Figure 4.)

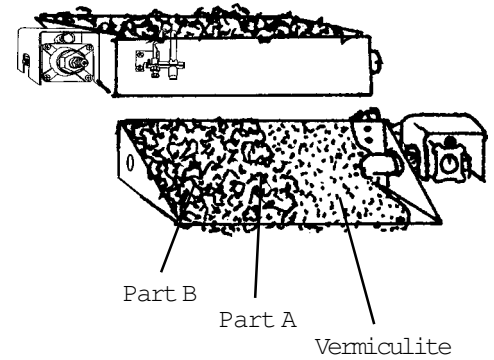
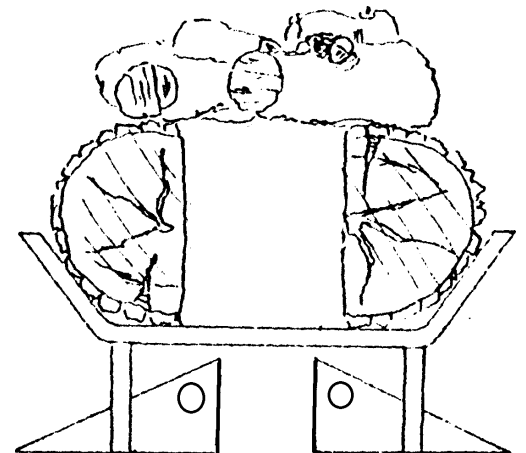

Figure 5



VOLCANIC CINDERS

1. The black **volcanic cinders** are used to cover the fireplace floor, fittings and tubing around the burner system. Although not functional, the black cinders act as a picture frame to show off the glowing embers and yellow flame.
2. The remaining 1/3 **Part A Embers** can now be spread over the volcanic cinders to look like additional fallen ash under the logs.

FOR YOUR SAFETY

Do not use this appliance if any part has been under water. Immediately call a qualified service technician to inspect the appliance and to replace any part of the system or gas control which has been under water.

Keep this appliance clear and free from combustible materials, gasoline, and other flammable vapors and liquids.

HARGROVE MANUFACTURING CORPORATION

LIMITED WARRANTY

Refractory Logs

Hargrove gas logs carry a limited lifetime warranty against any manufactured defect or breakage when installed indoors. A replacement will be available from the dealer at which the appliance was purchased. This warranty does not cover breakage caused by excessive handling once installed and fired. Outdoor applications carry a one (1) year limited warranty.

Burner & Grate

If the burner or grate fails due to deterioration within two (2) years of the verified purchase date, a free replacement will be made available from the dealer at which the appliance was purchased.

Valves, Remote Controls, & Switching Devices

Hargrove warrants all valves, remote controls and switching devices against manufacturing defects, which appear within two (2) years of the verified purchase date. Warranty does not cover products that have been damaged by misuse from overheating. Before any product is returned a Return Goods Authorization number (RGA) must be issued by Hargrove's Customer Service Department. All returns must be accompanied by an explanation of the problem and all necessary parts.

All Other Parts

If any assembled part should fail to operate or be found defective which appear within two (2) years of the verified purchase date, a replacement will be available from the dealer at which the appliance was purchased.

Buyer shall notify Hargrove Mfg Corp. of any defect covered by this warranty no later than thirty (30) days after defect is discovered. Failure to provide notice within thirty (30) days shall void the limited warranty.

WHAT IS NOT COVERED

1. Removal and reinstallation costs.
2. Labor costs for replacement or repairs.
3. Transportation or shipping cost.
4. The cost of a service call to diagnose trouble.
5. Painted Surfaces.
6. Damage or defect caused by improper installation, accident, misuse, abuse, alteration, or authorized service technician.
7. Replacement of burner or combustion chamber resulting from improper storage of the appliance.

LIMITATIONS AND EXCLUSIONS

1. No one has authority to add to or vary this limited warranty, or to create for Hargrove Manufacturing Corporation any other obligation or liability in connection with this appliance.
2. Any implied warranty applicable to this appliance is limited in duration to the same period of time as this written Warranty. Some states do not allow limitations on how long an implied warranty lasts, so the above limitations may not apply to you.
3. HARGROVE MANUFACTURING CORPORATION WILL NOT BE LIABLE FOR INCIDENTAL, CONSEQUENTIAL, SPECIAL OR CONTINGENT DAMAGES YOU MIGHT SUFFER AS A RESULT OF A CLAIM UNDER THIS WRITTEN WARRANTY OR ANY IMPLIED WARRANTY. Some states do not allow the exclusion or limitation of incidental or consequential damages, so the above limitations or exclusion may not apply to you.
4. This warranty applies only to the original purchaser and may not be transferred or assigned.
5. If you cannot verify the purchase date of the appliance, the warranty period will begin on the date of which the appliance was manufactured.
6. Replacement or repair parts are warranted for the remaining period of the original part warranty. Warranty parts must be obtained through authorized dealers of this product who will provide original factory replacement parts. Failure to use original factory replacement parts voids this warranty.
7. The maximum liability of Hargrove Mfg Corp. in connection with this limited warranty shall not in any case exceed the contract price paid for the product claimed to be defective or unsuitable.
8. Purchaser or user agrees to hold Hargrove Mfg Corp. harmless from any and all claims by the buyer as a result of injury or damage to an ultimate user or other person caused by the product sold herein by the seller to the buyer, whether the injury or damage results from the assembly, installation, operation, shipment, storage, or manufacture of this product. Hargrove Mfg Corp. makes no warranties, expressed or implied, other than those expressly stated herein.

YOUR DUTIES

This appliance must be installed by a qualified installer, operated and maintained in accordance with all applicable codes and the instructions furnished with the appliance. You must provide a receipt verifying the purchase date of the appliance when making a warranty claim with the dealer from which the appliance was purchased.

This warranty gives you specific legal rights, and you may also have other rights, which vary from state to state.

To register your Hargrove product, please visit our website at <http://www.hargrovegaslogs.com/reg.htm>.

CONTACT INFO: Hargrove Manufacturing Corp.

Tele: (800) 725-4166